

Operating instructions

Dopplersimulator MDS 24 for the adjustment of lane change assistance systems

Manufacturer	Heicks Industrieelektronik GmbH, Am Schwarzen Weg 25-31, D-59590 Geseke
Distributor	Heicks Vertriebs-GmbH, Am Schwarzen Weg 25-31, D-59590 Geseke
Product version	V001764 - Dopplersimulator MDS 24 – OEM Type 2

This operating instruction summarises the most important information about the Dopplersimulator MDS 24 in a clear form.

Purpose of the Dopplersimulator MDS 24

The Dopplersimulator MDS 24 is a tool for electronic calibration and functional testing of the angle measurement capability of vehicle radars.

This functional testing and calibration takes place in vehicle production or in customer service workshops. Since lane change radar systems can only detect moving objects, a stationary calibrator would not be detected. To circumvent this, the doppler effect is used for calibration. For this purpose, a metallic roller rotates in the housing of the Dopplersimulator MDS 24 and is thus detected by the lane change radar like a moving object, although it is set up at a fixed position.



Radar functionality





In the Dopplersimulator MDS 24, a metallic, cylindrical roller of a special, rotating radar modulator is mounted. A motor rotates this roller at a constant, defined speed. This rotating roller generates a line-shaped backscatter for the radar waves of the radar to be calibrated and modulates the radar waves according to the doppler effect. Due to the choice of special materials, the reflected area of the Dopplersimulator MDS 24 is approximately line-shaped. Furthermore, the slot allows the radar to be calibrated to look only at one half of the roller. Otherwise, the radar would see positive and negative relative velocities, which would have disadvantages with certain radar receivers. The sifter therefore selects positive from negative relative velocity components, thereby ensuring good sideband suppression in the Doppler modulated backscatter signal.

For radars that can measure the angle to the vehicle's longitudinal axis (azimuth angle), the Dopplersimulator MDS 24 is well suited for calibrating this angle measurement capability. For this purpose, the roller, slot and also the backscattering line are set up on edge or vertically in the radar's field of view. Thus, even for varying heights of the radar in relation to the Dopplersimulator MDS 24, the radar always sees the backscatter of the Dopplersimulator MDS 24 at a certain azimuth angle.

Notes for using the operating instructions

- This instruction manual contains important information for operator safety.
- The operating instructions should be read completely. Pay particular attention to the first pages with the safety instructions. The safety instructions are intended solely for protection during work with the machine.
- In order to prevent danger to persons and equipment or incorrect operation, it is advisable to refer to the individual work steps again separately while using the device.
- The device may only be used by a person with motor vehicle technical training. Information and knowledge that includes this training are not listed in this operating manual.
- The manufacturer reserves the right to make changes to the operating instructions and to the unit itself without prior notice. We therefore recommend that you check for any updates. In the event of resale or any other form of transfer, this operating manual must be enclosed with or quoted from the unit.

Symbols used

	<p>Danger / Warning / Caution This sign indicates a potentially hazardous situation which, if not avoided, could result in death or serious injury.</p>		<p>CROSSED BIN This sign indicates that the product must not be thrown into household waste. The bar below the gauze bin indicates whether the product was placed on the market after 13.08.2005.</p>
	<p>This sign indicates a dangerous electrical voltage/high voltage.</p>		<p>NOTE The texts marked with NOTE contain important and useful information. It is recommended that you read these texts.</p>

Safety instructions

General safety instructions

	<ul style="list-style-type: none"> • The Dopplersimulator MDS 24 is intended exclusively for use on motor vehicles. The use of the Dopplersimulator MDS 24 requires the user to have technical knowledge of the vehicle and thus knowledge of the sources of danger and risks in the workshop or the vehicle. • Before using the device, the user must have read the operating instructions completely and carefully. <ul style="list-style-type: none"> ○ Each Doppler Simulator is protected against solid foreign bodies with a diameter of less than 12.5 mm and against access with a finger (IP 20). ○ Each Doppler Simulator is delivered sealed with screws. ○ Due to the rotating rotor and fan inside, there is no risk of injury during operation as long as the housing remains closed. The housing may only be opened by the manufacturer and his trained personnel. ○ The Doppler Simulator is suitable for dry indoor use only. • If the velocity level falls below the tolerance limit, the green LED will turn off. Unplug the device when the red LED lights up continuously and contact the manufacturer to have the device checked. • All the instructions given in the individual chapters of the operating manual apply. The following measures and safety instructions must also be observed. • Furthermore, all general regulations of trade supervisory authorities, employers' liability insurance associations, motor vehicle manufacturers, environmental protection requirements as well as all laws, ordinances and codes of practice to be observed by a workshop apply.
---	---

Safety instructions Dopplersimulator MDS 24

	<p>To avoid incorrect handling and resulting injuries to the user or destruction of the Dopplersimulator MDS 24, observe the following:</p> <ul style="list-style-type: none"> • Protect the Dopplersimulator MDS 24 from hard impacts and do not drop it. • Protect the Dopplersimulator MDS 24 from prolonged exposure to sunlight. • The Dopplersimulator MDS 24 is not waterproof. Protect the Heicks Dopplersimulator MDS 24 from liquids such as water, fuel, oil, etc. • If the Dopplersimulator MDS 24 is damaged, accurate adjustment of the radar sensors is no longer ensured and the warranty and guarantee will become void.
---	---

Safety instructions High/mains voltage

	<p>Very high voltages occur in electrical systems. Voltage flashovers on damaged components, e.g. marten bites or touching live components, pose a risk of electric shock. High voltage via the vehicle and mains voltage via the house mains can cause serious injuries or death if insufficient attention is paid. Therefore, observe the following:</p> <ul style="list-style-type: none"> • Only use power supply cables with grounded protective contact. • Use only tested or enclosed power supply cable. • Only use the original cable set. • Check the cables and power supply units regularly for damage. • Do not touch live components when working with the ignition switched on.
---	---

Device description

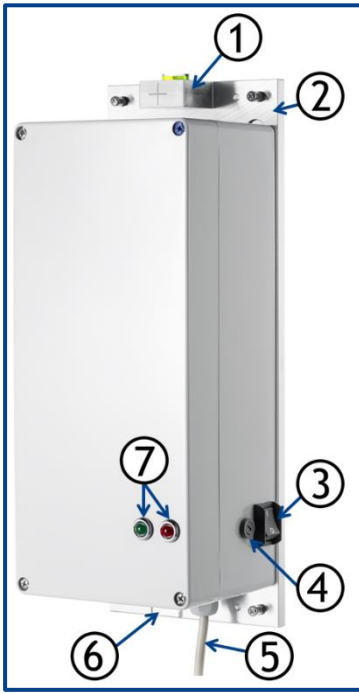

<p>Spirit level ① The Dopplersimulator MDS 24 can be aligned using the spirit level mounted on the base plate.</p>
<p>Base plate ② The Dopplersimulator MDS 24 is permanently mounted at the target location through existing holes in the base plate.</p>
<p>On/Off switch ③ The Dopplersimulator MDS 24 can be switched on or off via the on/off switch.</p>
<p>Fuse ④ The fuse serves as a protective device against e.g. short circuit.</p>
<p>Input socket for power supply ⑤ The Dopplersimulator MDS 24 must be supplied with voltage via the voltage supply socket using an approved power supply unit.</p>
<p>Mirror ⑥ Using the existing mirror on the extended base plate, the Dopplersimulator MDS 24 can be precisely aligned with the radar sensor using reflection.</p>
<p>LED control lights ⑦</p> <ul style="list-style-type: none"> • Green: The device is working within the specified tolerances • Red: Device is outside the specified tolerances

Housing labeling (exemplary)

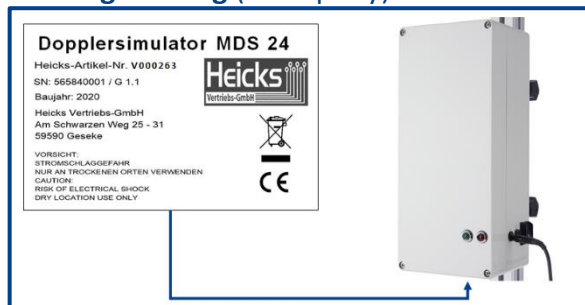

General test conditions

In a range of ambient temperature from +5°C to +30°C at max. 80% relative humidity, no condensation, the proper function of the device is guaranteed.

Electrical function control (electronic monitoring of speed)

	<p>NOTE</p> <ul style="list-style-type: none"> • After switching on the Dopplersimulator MDS 24, the red control lamp lights up first. If the Doppler simulator MDS 24 is working within its intended tolerances, the green LED lights up. This procedure can take up to 10 seconds. • The Dopplersimulator MDS 24 continuously checks its parameters. It can happen that the red control lamp lights up even during operation if the tolerances are exceeded. In this case, no usable measurements can be carried out. • If the red LED lights up continuously or for longer than 5 minutes, there is an error case in the device. Please contact the service point: Heicks Vertriebs-GmbH, Am Schwarzen Weg 25-31, 59590 D-Geseke Tel. +49 2942 / 97926 - 0; E-Mail info@heicks.de
--	--

To start up the Dopplersimulator MDS 24, proceed as follows:

1. Switch on the Dopplersimulator MDS 24 using the on/off switch. The red control light lights up.
2. Wait until the green control light lights up (approx. 5 seconds). When the green control light lights up, the Dopplersimulator MDS 24 is ready for operation.

Technical data Dopplersimulator MDS 24 (Heicks article no. V001764)

Dimensions housing	hight 340 x lenght 150 x width 120 mm
Dimensions base plate	hight 400 x lenght 150 x width 10 mm
Weight	3,85 kg
Power supply	Cable, 7-core, length 3,5m with 24V connection
Power consumption	The starting power consumption is approx. 1000mA for a short time - during operation the power consumption is approx. 600mA.
Mains switch	On/Off
Fuse	IEC 60127-2, 250 VAC, Inert T 0.5A, 5mm x 20mm
Operating light	<ul style="list-style-type: none"> • Green: The device is working within the specified tolerances • Red: Device is outside the specified tolerances
Fastening	By telescopic profile and accessories
Protection class	IP 20
Climate	Ambient temperature between +5 and +30°C; Relative humidity 80
Rated voltage	24V DC (Permissible input voltage 22V to 26V)
Cable connection assignment	Pin 1 – Colour white Signal ground Hallgenerator
	Pin 2 – Colour green Signal output Hallgenerator
	Pin 3 – Colour blue Power supply ground
	Pin 4 – Colour brown Power supply +24V DC
	Pin 5 – Colour grey Potential free Relay contact 24 V (normally open contact)
	Pin 6 – Colour pink Potential free Relay contact 24 V (centre contact)
	Pin 7 – Colour yellow Potential free Relay contact 24 V (normally closed contact)

Terminal assignment / Connection cable

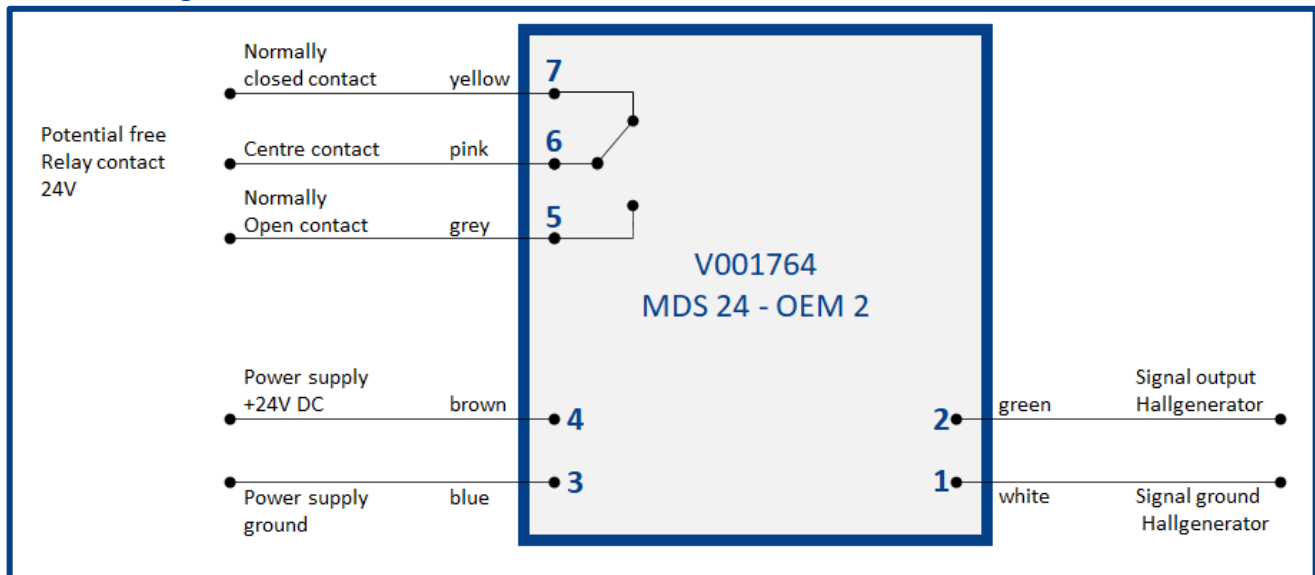

The contacts for the Hall generator are not connected in version V000235 (MDS 24 - OEM 1)

Care and maintenance

- Clean the Dopplersimulator MDS 24 regularly with mild cleaning agents.
- Use commercially available household cleaners in conjunction with a moistened soft cleaning cloth.
- Replace damaged accessories immediately.
- Only use original spare parts.
- The Dopplersimulator MDS 24 should be checked and/or calibrated at regular intervals (Recommendation: annually). This calibration can only be carried out by the manufacturer on a measuring station originally approved by the manufacturer. The HF properties are checked. For this, the Dopplersimulator MDS 24 must be sent to the manufacturer.

Disposal



In accordance with Directive 2012/19/EU of the European Parliament and of the Council of 4 July 2012 on waste electrical and electronic equipment (WEEE) and the national law on the sale, return and environmentally sound disposal of electrical and electronic equipment (Electrical and Electronic Equipment Act - ElektroG) of 16 March 2005, we undertake to take back this device, which we placed on the market after 13 August 2005, free of charge at the end of its useful life and to dispose of it in accordance with the above-mentioned directives. Since this appliance is used exclusively for commercial purposes (B2B), it must not be handed in to public waste disposal companies.

The appliance can be disposed of, stating the date of purchase and the appliance numbers, at:
Heicks Vertriebs-GmbH, Am Schwarzen Weg 25-31, D-59590 Geseke
WEEE-Reg.-Nr. DE 79348453
Tel.: +49 2942/97926-0, Fax: +49 2942/97926-150, Mail: info@heicks.de

Simplified declaration of conformity (European Union)

This device fulfills the essential requirements and other relevant provisions of directives 2014/35/EU (low voltage directive), 2014/30/EU (EMC directive), 2011/65/EU (directive for certain hazardous substances), 2012/19/EU (EU directive on waste electrical and electronic equipment). The user can recognize this directly from the CE mark. The full text of the EU declaration of conformity is available from the manufacturer.

